

## Modular Seating system

**Seat:** plywood and non-deformable polyurethane foam covered with polyester padding.

**Back:** metal frame and cold-injected polyurethane foam

**Fire retardant foam meeting California Bulletin 117A, EN1021-1/2 and Italian Class 1 IM Standards.**

**Base:** metal in powder coated finish.

**Covers:** fabric, faux-leather, or C.O.M (preferably in solid colours).



3 LOUNGE SEATING

	Article	Upholstery	Seat Only	Seat+ 1 Backrest	Seat + 2 Backrests	Seat + 3 Backrests	pcs/ dimensions volume / gross weight/ product net weight
Module 1 Seat	From I340 To I341	Gazebo Xtreme Plus / Magnum / Rivet / Main Line Flax Blazer / Gingko / Step Melange / Silvertex / Remix3 Steelcut Trio3 / Atlas / Canvas2 Leather C.O.L. C.O. faux leather / C.O.M. (solid colour)					1 pc / 80X83X53 cm 0,35 m3 / 25Kg 18 Kg  <b>Backrest</b> 1 pc / 83X26X112,5cm 0,24 m3 / 18 Kg 14,5 Kg
Module 1.5 seat	From I342 To I344	Gazebo Xtreme Plus / Magnum / Rivet / Main Line Flax Blazer / Gingko / Step Melange / Silvertex / Remix3 Steelcut Trio3 / Atlas / Canvas2 Leather C.O.L. C.O. faux leather / C.O.M. (solid colour)					1 pc / 135X83X53cm 0,53 m3 / 34 Kg 26,5 Kg  <b>Backrest</b> 1 pc / 83X26X112,5cm 0,24 m3 / 18 Kg 14,5 Kg
Module 3 seats	From I345 To I358	Gazebo Xtreme Plus / Magnum / Rivet / Main Line Flax Blazer / Gingko / Step Melange / Silvertex / Remix3 Steelcut Trio3 / Atlas / Canvas2 Leather C.O.L. C.O. faux leather / C.O.M. (solid colour)					1 pc / 239X83X53 cm 1,1 m3 / 68Kg 60 Kg  <b>Backrest</b> 1 pc / 83X26X112,5cm 0,24 m3 / 18 Kg 14,5 Kg
Curved Module	From I359 To I367	Gazebo Xtreme Plus / Magnum / Rivet / Main Line Flax Blazer / Gingko / Step Melange / Silvertex / Remix3 Steelcut Trio3 / Atlas / Canvas2 Leather C.O.L. C.O. faux leather / C.O.M. (solid colour)					1 pc / 216X150X53 cm 1,62 m3 / 63 Kg 55 Kg  <b>Backrest</b> 1 pc / 83X26X112,5cm 0,24 m3 / 18 Kg 14,5 Kg

## Dimensions

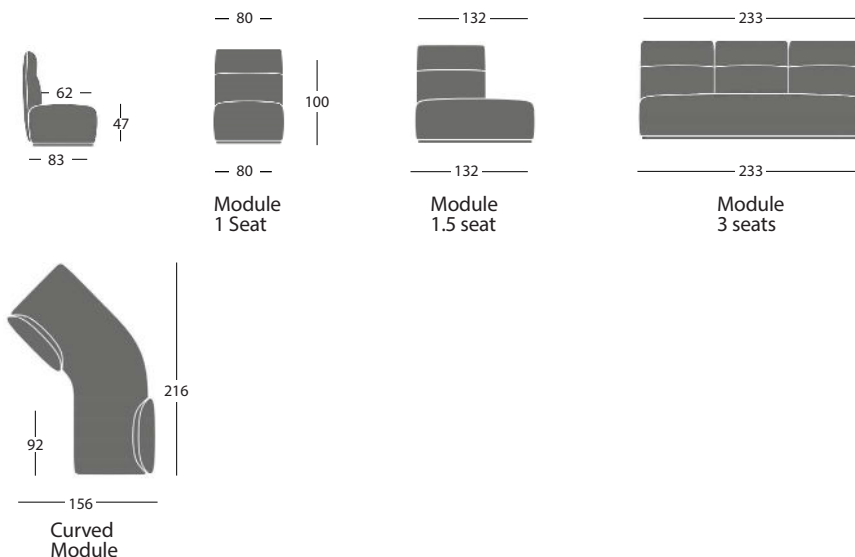

## Additional cost :( please contact Segis Office )

- Built-in power modules (USB or socket ) available as option upon request
- Upholstery in two different materials

## Customer's own material

For customer's own material/leather, the form at the end of the price list shall apply, to be sent to Segis Spa with the Client's signature.

**One Seat**  
Solid fabric: for 1 pc 330 cm (H.140 cm)  
C.O.L. qty: for 1 pc 6 m2

**1.5 Seat**  
Solid fabric: for 1 pc 400 cm (H.140 cm)  
C.O.L. qty: for 1 pc 7,30m2

**3 Seats**  
Solid fabric: for 1 pc 500 cm (H.140 cm)  
C.O.L. qty: for 1 pc 9,10m2

**Curved Module**  
Solid fabric: for 1 pc 600 cm (H.140 cm)  
C.O.L. qty: for 1 pc 11 m2

**Backrest**  
Solid fabric: for 1 pc 220 cm (H.140 cm)  
C.O.L. qty: for 1 pc 4 m2

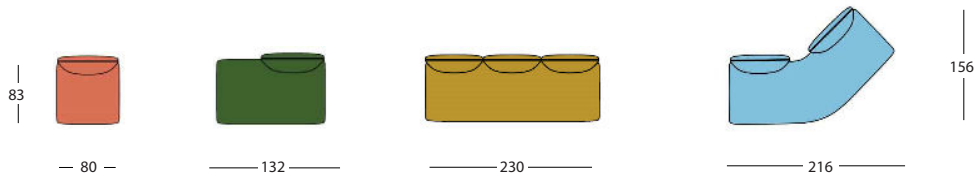

I340



I341



I342



I343



I344



I345



I346



I347



I348



I349



I350



I351



I352



I353



I354



I355



I356



I357



I358

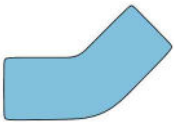

I359

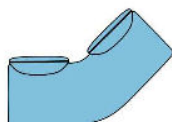

I360



I361



I362

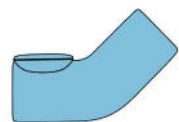

I363

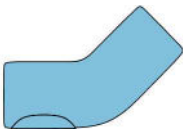

I364



I365



I366

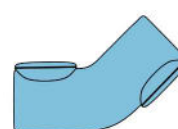

I367

## Finishes

### Metal Frame

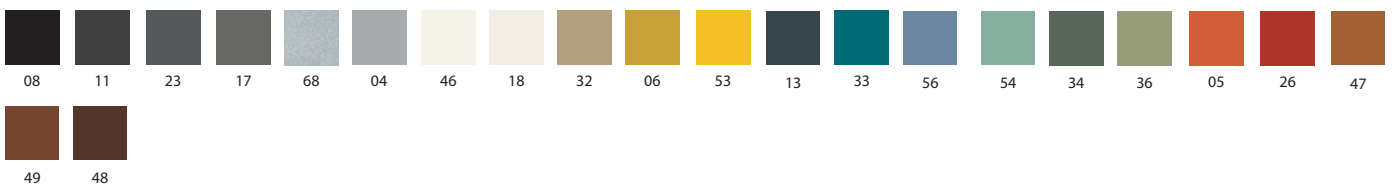

Multifunctional table with turnable table top.

Frame: Metal powder coated finish

Top: HPL laminate Ø 40 cm

Possibility to install it along the perimeter of the seat



3 LOUNGE SEATING

Article	pcs/ dimensions volume / gross weight/ product net weight
Table Ø 40 cm      MTAVSKY	1 pc / 42X67X12cm 0.03 m <sup>3</sup> / 7 Kg 4 Kg

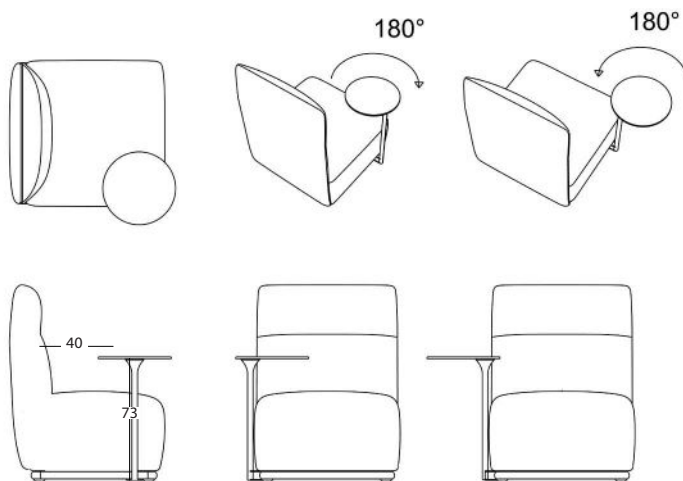

## Finishes

Metal Legs

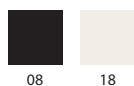

08

18

## Tops

HPL



BI

NR\*