

Modulares Sitzsystem

Struktur: Schichtholz mit Polsterung aus nicht verformbarem Polyurethan, abgedeckt mit Polyesterwatte feuerhemmend

Rückenschale: Innenstruktur aus Metall und Kaltgeschäumtem Polyurethan, feuerhemmend nach dem **Standard EN 1021:2014, Standard "California Bulletin 117A" und Italienischem Standard Klasse 1 IM.**

Sockel: aus epoxydlackiert Metall

Bezug: Stoff, Leder, Kunstleder oder kundeneigenes Bezugsmaterial, Unifarben bevorzugt



	Artikel	Bezug	Nur Sitz	Sitz + 1 Rückenschal	Sitz + 2 Rückenschalen	Sitz + 3 Rückenschalen	Stück / Kartonmass Kubikmeter / Bruttogewicht Nettogewicht
Modul 1 Sitz	Von I340 Bis I341	Gazebo Xtreme Plus / Magnum / Rivet / Main Line Flax Blazer / Gingko / Step Melange / Silvertex / Remix3 Steelcut Trio3 / Atlas / Canvas2 Leder Kundenleder Kunden-Kunstleder / Kundenstoff					1 Stk / 80X83X53 cm 0,35 m ³ / 25Kg 18 Kg Rückenschale 1 Stk / 83X26X112,5cm 0,24 m ³ / 18 Kg 14,5 Kg
Modul 1.5 Sitz	Von I342 Bis I344	Gazebo Xtreme Plus / Magnum / Rivet / Main Line Flax Blazer / Gingko / Step Melange / Silvertex / Remix3 Steelcut Trio3 / Atlas / Canvas2 Leder Kundenleder Kunden-Kunstleder / Kundenstoff					1 Stk / 135X83X53cm 0,53 m ³ / 34 Kg 26,5 Kg Rückenschale 1 Stk / 83X26X112,5cm 0,24 m ³ / 18 Kg 14,5 Kg
Modul 3 Sitzler	Von I345 Bis I358	Gazebo Xtreme Plus / Magnum / Rivet / Main Line Flax Blazer / Gingko / Step Melange / Silvertex / Remix3 Steelcut Trio3 / Atlas / Canvas2 Leder Kundenleder Kunden-Kunstleder / Kundenstoff					1 Stk / 239X83X53 cm 1,1 m ³ / 68Kg 60 Kg Rückenschale 1 Stk / 83X26X112,5cm 0,24 m ³ / 18 Kg 14,5 Kg
Gebogenes Modul	Von I359 Bis I367	Gazebo Xtreme Plus / Magnum / Rivet / Main Line Flax Blazer / Gingko / Step Melange / Silvertex / Remix3 Steelcut Trio3 / Atlas / Canvas2 Leder Kundenleder Kunden-Kunstleder / Kundenstoff					1 Stk / 216X150X53 cm 1,62 m ³ / 63 Kg 55 Kg Rückenschale 1 Stk / 83X26X112,5cm 0,24 m ³ / 18 Kg 14,5 Kg

Aufpreis

Abmessungen

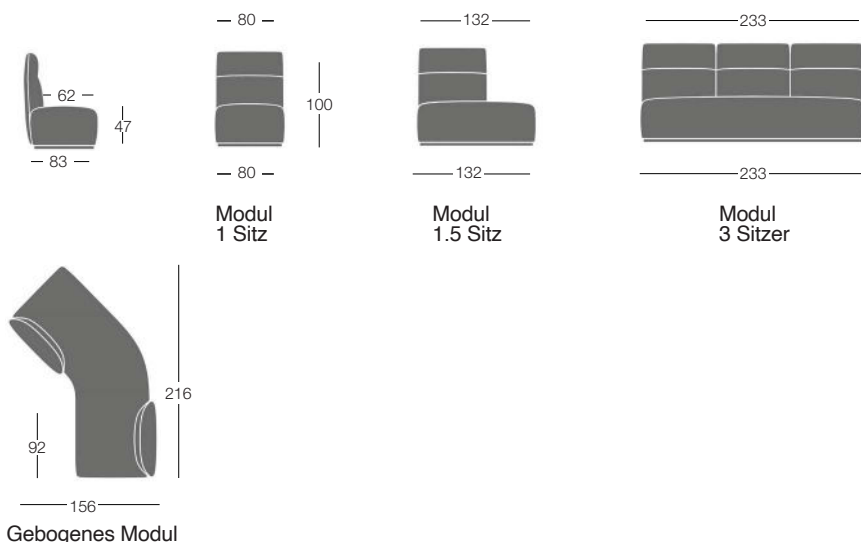

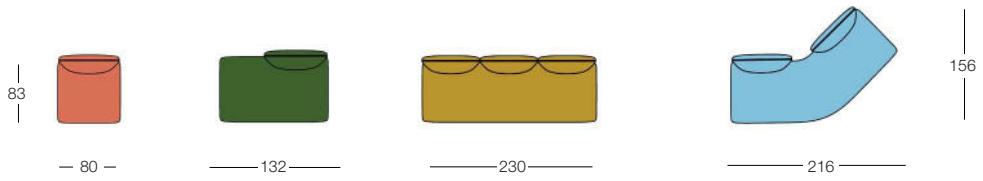

I340



I341



I342



I343



I344



I345



I346



I347



I348



I349



I350



I351



I352



I353



I354



I355



I356

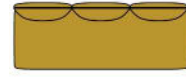

I357

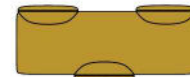

I358

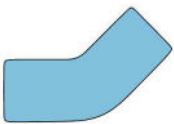

I359

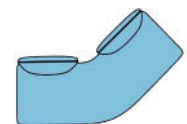

I360



I361



I362

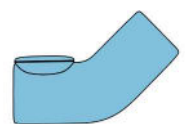

I363

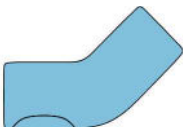

I364



I365



I366

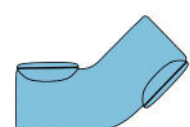

I367

Ausführung

Gestell

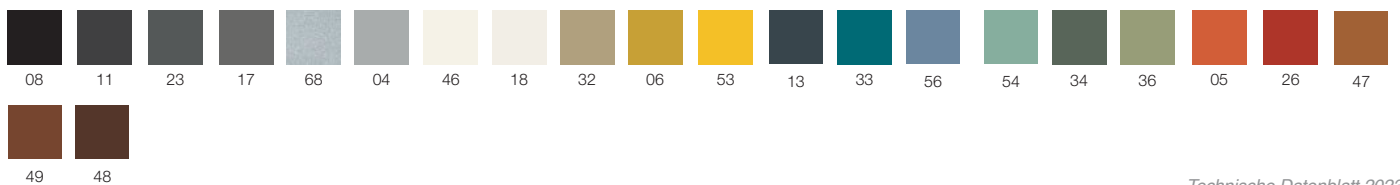

Multifunktionsstisch mit drehbarer Tischplatte.

Gestell : Metal powder coated finish

Top: Metall Ø 40 cm



Artikel

Tisch Ø 40 cm

MTAVSKYMET

Stück / Kartonmass
Kubikmeter / Bruttogewicht
Nettogewicht

1 Stk / 42X67X12cm
0.03 m³ / 7 Kg
4 Kg

3 POLSTERMÖBEL

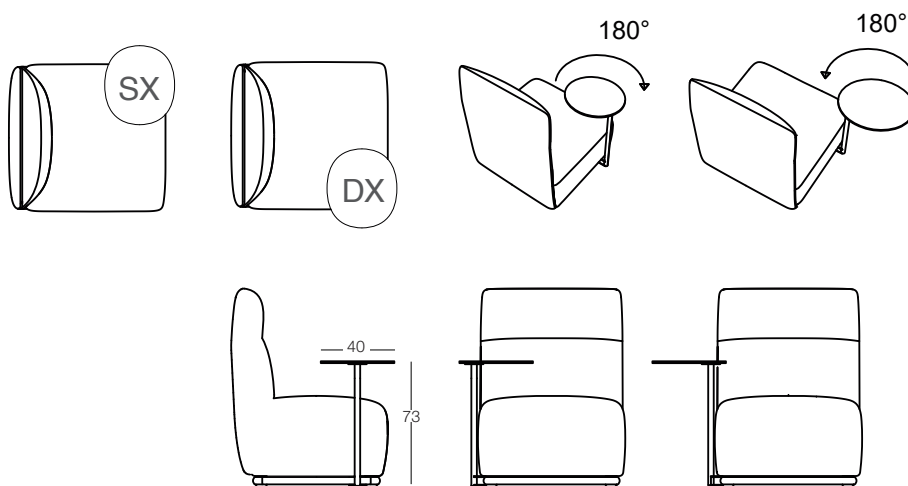

Ausführung

Gestell / Tischplatte

