

Système modulaire d'assises rembourrées.

Assise en multiplis avec rembourrage en polyuréthane indéformable recouverte d'ouate de polyester.

Résistance au feu du rembourrage interne selon la norme française M4, EN 1021-1/2, italienne classe 1 IM et selon les normes du California Bulletin 117A

Base : en acier en finition époxy laquée.

Revêtement : tissu, cuir, similicuir ou matériel client (de préférence teinte unie).



Article	Revêtement	Assise seule	Assise+ 1 Dossier	Assise + 2 Dossiers	Assise + 3 Dossiers	pcs / dim. carton volume / poids brut poids net
Module 1 place de 1340 à 1341	Gazebo Xtreme Plus / Magnum / Rivet / Main Line Flax Blazer / Gingko / Step Melange / Silvertex / Remix3 Steelcut Trio3 / Atlas / Canvas2 Cuir Cuir client Tissu client-similicuir client (teinte unie)					1 pc / 80X83X53 cm 0,35 m3 / 25Kg 18 Kg Dossier: 1 pc / 83X26X112,5cm 0,24 m3 / 18 Kg 14,5 Kg
Module 1.5 de places 1342 à 1344	Gazebo Xtreme Plus / Magnum / Rivet / Main Line Flax Blazer / Gingko / Step Melange / Silvertex / Remix3 Steelcut Trio3 / Atlas / Canvas2 Cuir Cuir client Tissu client-similicuir client (teinte unie)					1 pc / 135X83X53cm 0,53 m3 / 34 Kg 26,5 Kg Dossier: 1 pc / 83X26X112,5cm 0,24 m3 / 18 Kg 14,5 Kg
Module 3 places de 1345 à 1358	Gazebo Xtreme Plus / Magnum / Rivet / Main Line Flax Blazer / Gingko / Step Melange / Silvertex / Remix3 Steelcut Trio3 / Atlas / Canvas2 Cuir Cuir client Tissu client-similicuir client (teinte unie)					1 pc / 239X83X53 cm 1,1 m3 / 68Kg 60 Kg Dossier: 1 pc / 83X26X112,5cm 0,24 m3 / 18 Kg 14,5 Kg
Module Courbe de 1359 à 1367	Gazebo Xtreme Plus / Magnum / Rivet / Main Line Flax Blazer / Gingko / Step Melange / Silvertex / Remix3 Steelcut Trio3 / Atlas / Canvas2 Cuir Cuir client Tissu client-similicuir client (teinte unie)					1 pc / 216X150X53 cm 1,62 m3 / 63 Kg 55 Kg Dossier: 1 pc / 83X26X112,5cm 0,24 m3 / 18 Kg 14,5 Kg

Dimensions

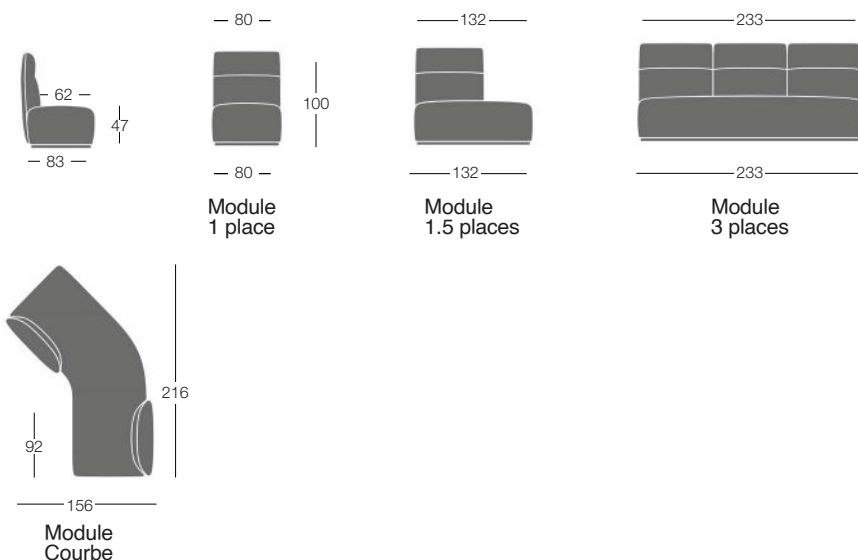

Supplements :

contacter le service commercial Segis

- Possibilité d'électrification
- Revêtement avec deux tissus différents

Matériel client

Pour l'envoi de tissu client, similicuir client ou cuir client, se reporter au formulaire à la fin du tarif à retourner impérativement complété et signé.

Module 1 place

Métrage pour tissu en teinte unie pour 1 pc: 330 cm (H.140 cm)
Métrage cuir pour 1 pc: 6 m2

Module 1.5 place

Métrage pour tissu en teinte unie pour 1 pc: 400 cm (H.140 cm)
Métrage cuir pour 1 pc: 7,30 m2

Module 3 places

Métrage pour tissu en teinte unie pour 1 pc: 500 cm (H.140 cm)
Métrage cuir pour 1 pc: 9,10 m2

Module Courbe

Métrage pour tissu en teinte unie pour 1 pc: 600 cm (H.140 cm)
Métrage cuir pour 1 pc: 11 m2

Dossier

Métrage pour tissu en teinte unie pour 1 pc: 220 cm (H.140 cm)
Métrage cuir pour 1 pc: 4 m2

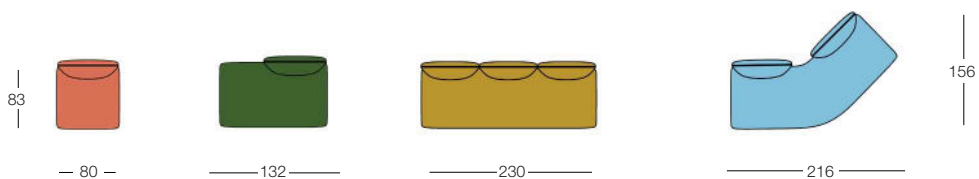

I340



I341



I342



I343



I344



I345



I346



I347



I348



I349



I350



I351



I352



I353



I354



I355



I356

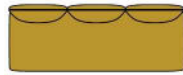

I357



I358

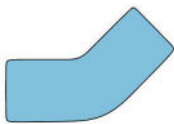

I359



I360

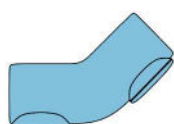

I361



I362

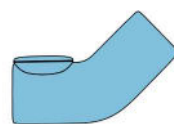

I363

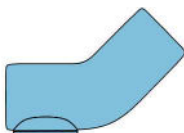

I364

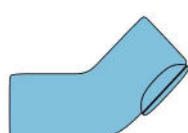

I365

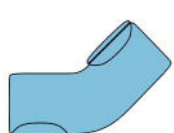

I366

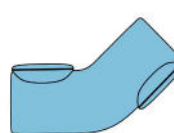

I367

Finitions

Piètement métal

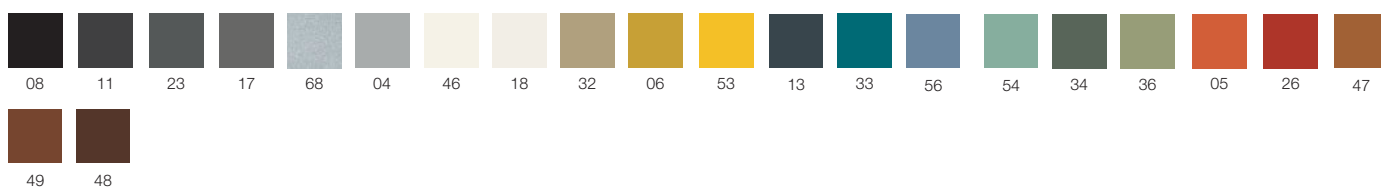

Table d'appoint avec plateau tournant.
Structure métal en finition époxy laquée.
Plateau : Ø 40 cm en finition époxy laqué.



Article

Métal

pcs / dim. carton
volume / poids brut
poids net

Table Ø 40 cm

MTAVSKYMET

1 pc / 42X67X12cm
0,03 m3 / 7 Kg
4 Kg

3 REMBOURRÉS

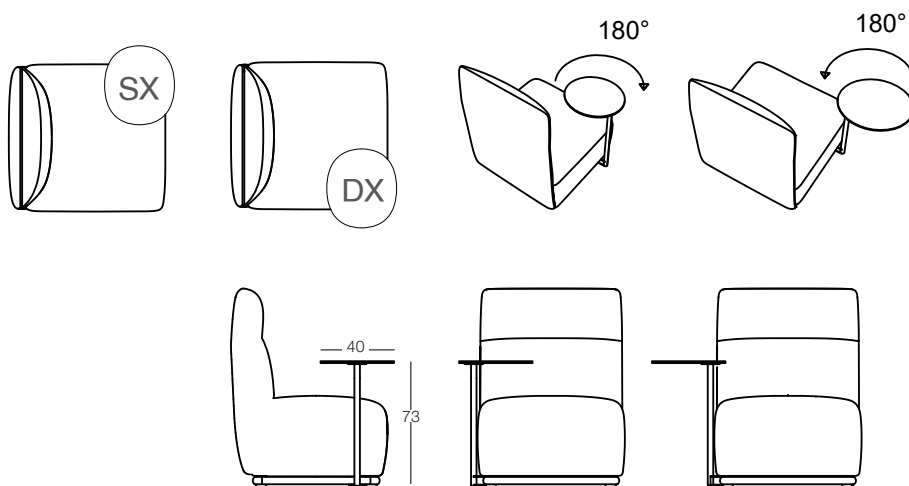

Notice

Spécifier la position de la table DX (droite) ou SX (gauche) au moment de la commande.

Droit (DX) ou gauche (SX) se réfère à la position quant on est assis.

Finitions

Table

